

Quarter turn actuators DFPD for the chemical industry

FESTO



Key features

Function

This design of the DFPD series is suitable for the harsh conditions in the chemical industry. DFPD and DFPD-VDE2 have a NAMUR interface to VDI/VDE 3847, hard-anodised end caps, blow-out-proof adjusting screws for the end position, shaft centring ring and captive spring cartridges that are free of non-ferrous metals.

The DFPD for the chemical industry is suitable for actuating butterfly valves, plug valves and ball valves in process plants in the chemical and petrochemical industries, and can also be used with a positioner for control applications.

At a glance



DFPD-...-C



DFPD-...-C-VDE2



DFPD-...-C-VDE2
DADG-FM-F9-VDE2



DFPD-...-C-VDE2
DADG-FM-F9-VDE2

Ordering data – Product options

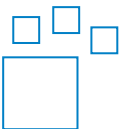

Configurable product
This product and all its product options can be ordered using the configurator.

The configurator can be found under
Products on the DVD or
→ www.festo.com/catalogue/...

Part no.	Type
8042185	DFPD-20
8042186	DFPD-40
8042187	DFPD-80
8042188	DFPD-120
8042189	DFPD-160
8042190	DFPD-240
8042191	DFPD-300
8042192	DFPD-480
8042193	DFPD-700
8042194	DFPD-900
8042195	DFPD-1200
8042196	DFPD-2300

Key features and type codes

Size	Flange pattern	Shaft connection	Shaft connection depth [mm]	Pneumatic connection
20	F05	T11	12	G1/8
40	F05	T14	16	G1/8
80	F07	T17	19	G1/8
120	F07	T17	19	G1/4
160	F07	T22	24	G1/4
240	F10	T22	24	G1/4
300	F10	T27	24	G1/4
480	F12	T27	29	G1/4
700	F12	T27	29	G1/4
900	F14	T36	38	G1/4
1200	F14	T36	38	G1/4
2300	F16	T46	48	G1/4

001	Series
DFPD	Semi-rotary drive

002	System of units
	Metric
N	Imperial

003	Size
20	20
40	40
80	80
120	120
160	160
240	240
300	300
480	480
700	700
900	900
1200	1200
2300	2300

004	Design
RP	Rack and pinion

005	Swivel angle [°]
90	90

006	Swivel direction
R	Right

007	Function
S	Single-acting

008	Spring force
35	For connection pressure 3.5 bar
45	For connection pressure 4.5 bar
60	For connection pressure 6 bar

009	Flange pattern 1
F05	Hole pattern F05
F07	Hole pattern F07
F10	Hole pattern F10
F12	Hole pattern F12
F14	Hole pattern F14
F16	Hole pattern F16

010	Pneumatic connection
	Standard
X	Alternative connection size

011	Shaft material
R3	Stainless steel

012	Industry focus
C	Chemical industry

013	Mechanical interface
	Standard
VDE2	VDI/VDE 3847-2

Peripherals overview

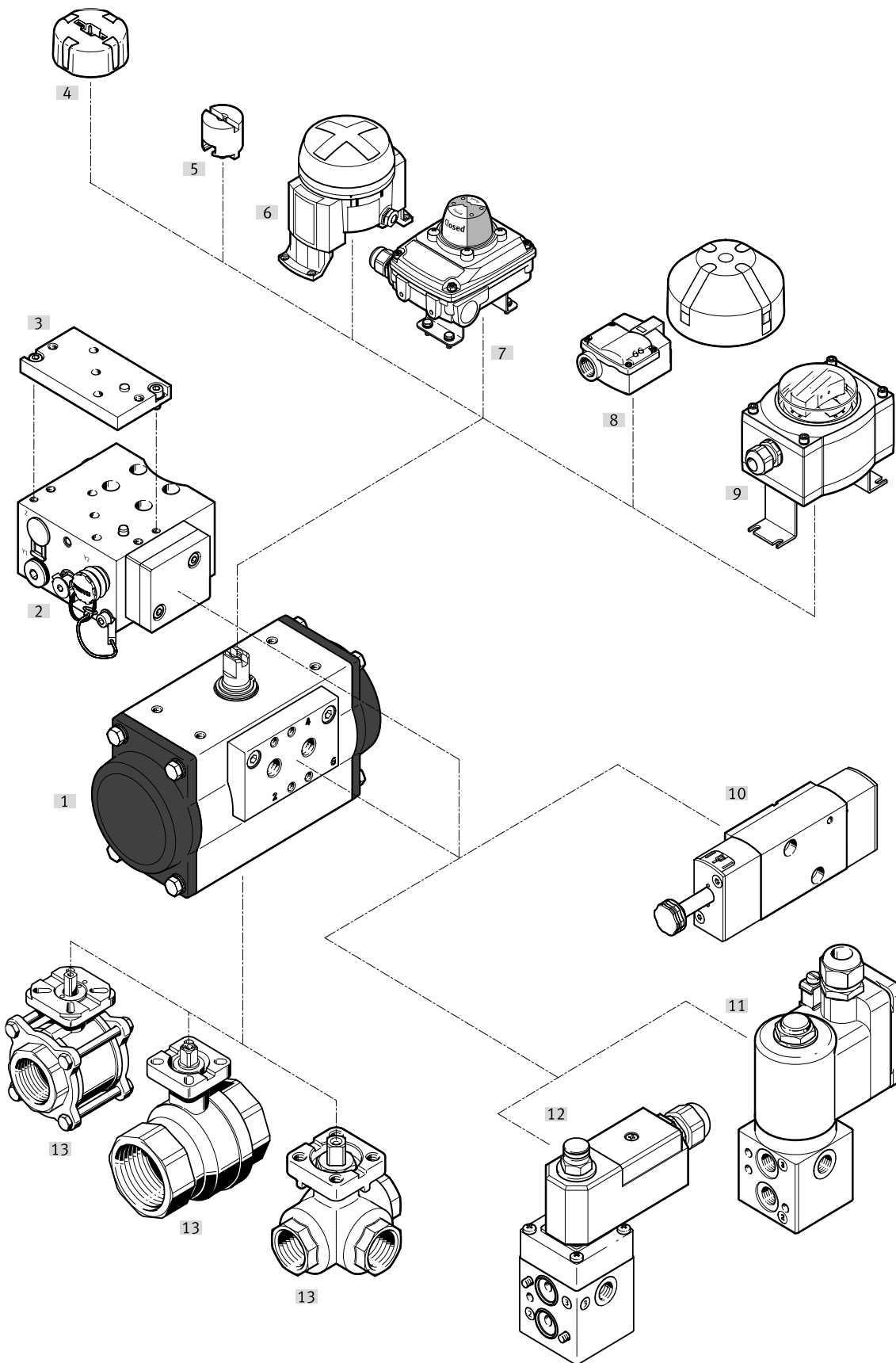



Peripherals overview

Mounting components and accessories		Description	→ Page/Internet
[1]	Quarter turn actuators DFPD-C	This design of the DFPD series is suitable for the harsh conditions in the chemical industry	6
[2]	Control plate DADG-FM-F9-VDE2	For sizes 80 to 2300	20
[3, 5]	Adapter kit DADG-AK-F9-1	The VDI/VDE 3847-2 interface is increased of 10 mm	23
[4]	Position indicator SASF	The different sizes of the SASF corresponds to the DFPD shaft size	25
[6]	Sensor box DAPZ	Round design, variant AR, electrical, inductive or inductive and explosion-proof sensing	dapz
[7]	Sensor box SRBC	For electrical feedback and position monitoring of process valves that are actuated with quarter turn actuators	srbc
[8]	Sensor box SRBG	For electrical feedback and position monitoring of process valves that are actuated with quarter turn actuators	srbg
[9]	Sensor box SRAP	Analogue sensor box continuously senses the entire swivel range and reports this back to the controller	srap
[10]	Solenoid valve VSNC	For single-acting and double-acting quarter turn actuators with a plug pattern to VDI/VDE 3845	vsnc
[11]	Solenoid valve VOFD	Solenoid valve with solenoid coil, plug pattern to NAMUR	vofd
[12]	Solenoid valve VOFC	Solenoid valve with solenoid coil, plug pattern to NAMUR	vofc
[13]	Ball valve VAPB, VZBA	2-way brass or stainless steel, corrosion-resistant; 3-way stainless steel, corrosion-resistant	vapb
-	Spring assembly DADG	Spring assembly size 20 to 2300, free of non-ferrous metals	25

Data sheet

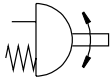
Function



 Swivel angle
0 ... 90°



General technical data

Size	20	40	80	120	160	240	300	480	700	900	1200	2300
Mode of operation	Single-acting											
Design	Gear rack/pinion											
Mounting position	Any											
Pneumatic connection	G1/8						G1/4					
Process valve connection to standard	ISO 5211											
Valve connection conforms to standard	VDI/VDE 3845 (NAMUR)											
Connection for positioner and position sensor conforms to standard	VDI/VDE 3845											
Size	AA 1						AA 2			AA 3		
Swivel angle [°]	90											
End-position adjustment range at 0° [°]	-5 ... +5											
End-position adjustment range at 90° [°]	-5 ... +5											
Closing direction	Closes to the right											

Operating and environmental conditions

Variant	RS35	RS45	RS60
Operating pressure [bar]	2 ... 8		
Nominal operating pressure [bar]	3.5	4.5	6
Operating medium	Compressed air to ISO 8573-1:2010 [7:4:4]		
Note on operating/pilot medium	Dew point at least 10°C below the ambient temperature and temperature of medium Lubricated operation possible (in which case lubricated operation will always be required)		
Ambient temperature [°C]	-20 ... +80		
Storage temperature [°C]	-20 ... +60		
Certificate issuing authority	German Technical Control Board (TÜV) Rheinland		

Data sheet

ATEX	
ATEX category for gas	II 2G
Type of ignition protection for gas	Ex h IIC T4 Gb X
ATEX category for dust	II 2D
Type of ignition protection for dust	Ex h IIIC T105°C Db X
Explosion-proof ambient temperature [°C]	-20 ≤ Ta ≤ +80
CE marking (see declaration of conformity)	To EU Explosion Protection Directive (ATEX)

Materials	
Sectional view	
Quarter turn actuators	
[1] Cover	Coated die-cast aluminium
[2] Housing	Anodised wrought aluminium alloy
– Shaft	High-alloy stainless steel
– Sub-base	Anodised wrought aluminium alloy
Piston	Die-cast aluminium
Seals	NBR
Spring	Spring steel
Bearing	POM
Cam	Stainless steel casting (DFPD-20...160...-RS)
	Steel (DFPD-240 ... 2300...-RS)
Screws	High-alloy stainless steel
Note on materials	RoHS-compliant

Air consumption [l/cycle] at 6 bar

Type		Type	
DFPD-20-RP-90-S	0.8	DFPD-700-RP-90-RS60	24.5
DFPD-40-RP-90-S	1.5	DFPD-900-RP-90-RS60	31.5
DFPD-80-RP-90-S	3.1	DFPD-1200-RP-90-RS60	43.5
DFPD-120-RP-90-S	4.3	DFPD-2300-RP-90-RS60	84.4
DFPD-160-RP-90-S	5.9		
DFPD-240-RP-90-S	8.6		
DFPD-300-RP-90-S	11		
DFPD-480-RP-90-S	17.2		

Data sheet

Theoretical torque [Nm] as a function of operating pressure [bar] and swivel angle [°]													
Spring configuration	Nominal swivel angle	Spring torque [Nm]	Operating pressure [bar]										
	[°]		2	2.5	3	3.5	4	4.5	5	5.5	6	7	8
Size DFPD-20													
20	0	2.4	4.9	6.7	8.6	10.4	12.2	14.0	15.9	17.7	19.5	23.2	26.8
	90	4.8	2.5	4.4	6.2	8.0	9.9	11.7	13.5	15.3	17.2	20.8	24.5
25	0	3.0	4.3	6.1	8.0	9.8	11.6	13.4	15.3	17.1	18.9	22.6	26.2
	90	6.0	1.4	3.2	5.0	6.8	8.7	10.5	12.3	14.2	16.0	19.6	23.3
30	0	3.6		5.5	7.4	9.2	11.0	12.8	14.7	16.5	18.3	22.0	25.6
	90	7.1		2.0	3.8	5.7	7.5	9.3	11.1	13.0	14.8	18.4	22.1
35	0	4.2			6.8	8.6	10.4	12.2	14.1	15.9	17.7	21.4	25.0
	90	8.3			2.6	4.5	6.3	8.1	9.9	11.8	13.6	17.3	20.9
40	0	4.8				8.0	9.8	11.6	13.5	15.3	17.1	20.8	24.4
	90	9.5				3.3	5.1	6.9	8.8	10.6	12.4	16.1	19.7
45	0	5.4					9.2	11.0	12.9	14.7	16.5	20.2	23.8
	90	10.7					3.9	5.7	7.6	9.4	11.2	14.9	18.5
50	0	6.0						10.4	12.3	14.1	15.9	19.6	23.2
	90	11.9						4.5	6.4	8.2	10.0	13.7	17.3
55	0	6.6							11.7	13.5	15.3	19.0	22.6
	90	13.1							5.2	7.0	8.8	12.5	16.1
60	0	7.2								12.9	14.7	18.4	22.0
	90	14.3								5.8	7.6	11.3	15.0
Size DFPD-40													
20	0	4.6	9.3	12.8	16.3	19.8	23.3	26.7	30.2	33.7	37.2	44.1	51.1
	90	9.1	4.8	8.3	11.8	15.3	18.8	22.3	25.7	29.2	32.7	39.7	46.6
25	0	5.8	8.2	11.7	15.1	18.6	22.1	25.6	29.1	32.6	36.0	43.0	50.0
	90	11.4	2.6	6.1	9.5	13.0	16.5	20.0	23.5	27.0	30.4	37.4	44.4
30	0	6.9		10.5	14.0	17.5	21.0	24.4	27.9	31.4	34.9	41.8	48.8
	90	13.6		3.8	7.3	10.8	14.2	17.7	21.2	24.7	28.2	35.1	42.1
35	0	8.1			12.8	16.3	19.8	23.3	26.8	30.3	33.7	40.7	47.7
	90	15.9			5.0	8.5	12.0	15.4	18.9	22.4	25.9	32.9	39.8
40	0	9.2				15.2	18.7	22.1	25.6	29.1	32.6	39.5	46.5
	90	18.2				6.2	9.7	13.2	16.7	20.1	23.6	30.6	37.5
45	0	10.4					17.5	21.0	24.5	28.0	31.4	38.4	45.4
	90	20.4					7.4	10.9	14.4	17.9	21.4	28.3	35.3
50	0	11.5						19.8	23.3	26.8	30.3	37.2	44.2
	90	22.7						8.6	12.1	15.6	19.1	26.0	33.0
55	0	12.7							22.2	25.7	29.1	36.1	43.1
	90	25.0							9.8	13.3	16.8	23.8	30.7
60	0	13.8								24.5	28.0	34.9	41.9
	90	27.2								11.1	14.5	21.5	28.5

 **Note**
 The operating torque of the actuator must not be higher than the maximum permissible torque listed in ISO 5211 in relation to the size of the mounting flange and of the coupling.

Data sheet

Theoretical torque [Nm] as a function of operating pressure [bar] and swivel angle [°]													
Spring configuration	Nominal swivel angle	Spring torque [Nm]	Operating pressure [bar]										
	[°]		2	2.5	3	3.5	4	4.5	5	5.5	6	7	8
Size DFPD-80													
20	0	9.9	20.1	27.6	35.1	42.6	50.0	57.5	65.0	72.5	80.0	95.0	110.0
	90	19.5	10.5	18.0	25.5	33.0	40.4	47.9	55.4	62.9	70.4	85.4	100.4
25	0	12.4	17.6	25.1	32.6	40.1	47.6	55.1	62.6	70.1	77.5	92.5	107.5
	90	24.4	5.6	13.1	20.6	28.1	35.6	43.1	50.6	58.1	65.5	80.5	95.5
30	0	14.8		22.6	30.1	37.6	45.1	52.6	60.1	67.6	75.1	90.1	105.0
	90	29.2		8.2	15.7	23.2	30.7	38.2	45.7	53.2	60.7	75.5	90.6
35	0	17.3			27.7	35.1	42.6	50.1	57.6	65.1	72.6	87.6	102.6
	90	34.1			10.9	18.3	25.8	33.3	40.8	48.3	55.8	70.8	85.8
40	0	19.8				32.7	40.2	47.7	55.1	62.6	70.1	85.1	100.1
	90	39.0				13.5	21.0	28.5	35.9	43.4	50.9	65.9	80.9
45	0	22.2					37.7	45.2	52.7	60.2	67.7	82.6	97.6
	90	43.8					16.1	23.6	31.1	38.6	46.1	61.0	76.0
50	0	24.7						42.7	50.2	57.7	65.2	80.2	95.2
	90	48.7						18.7	26.2	33.7	41.2	56.2	71.2
55	0	27.2							47.7	55.2	62.7	77.7	92.7
	90	53.6							21.3	28.8	36.3	51.3	66.3
60	0	29.6								52.8	60.3	75.2	90.2
	90	58.4								24.0	31.5	46.4	61.4
Size DFPD-120													
20	0	14.0	28.7	39.3	50.0	60.7	71.3	82.0	92.7	103.4	114.0	135.4	156.7
	90	27.8	14.9	25.6	36.3	46.9	57.6	68.3	79.0	89.6	100.3	121.7	143.0
25	0	17.6	25.1	35.8	46.5	57.2	67.8	78.5	89.2	99.9	110.5	131.9	153.2
	90	34.7	8.0	18.7	29.3	40.0	50.7	61.4	72.0	82.7	93.4	114.7	136.1
30	0	21.1		32.3	43.0	53.6	64.3	75.0	85.7	96.3	107.0	128.4	149.7
	90	41.6		11.7	22.4	33.1	43.7	54.4	65.1	75.8	86.4	107.8	129.1
35	0	24.6			39.5	50.1	60.8	71.5	82.2	92.8	103.5	124.8	146.2
	90	48.6			15.5	26.1	36.8	47.5	58.1	68.8	79.5	100.8	122.2
40	0	28.1				46.6	57.3	68.0	78.6	89.3	100.0	121.3	142.7
	90	55.5				19.2	29.9	40.5	51.2	61.9	72.6	93.9	115.2
45	0	31.6					53.8	64.5	75.1	85.8	96.5	117.8	139.2
	90	62.5					22.9	33.6	44.3	54.9	65.6	87.0	108.3
50	0	35.1						61.0	71.6	82.3	93.0	114.3	135.7
	90	69.4						26.7	37.3	48.0	58.7	80.0	101.4
55	0	38.6							68.1	78.8	89.5	110.8	132.2
	90	76.3							30.4	41.1	51.7	73.1	94.4
60	0	42.1								75.3	86.0	107.3	128.6
	90	83.3								34.1	44.8	66.1	87.5

 - Note

The operating torque of the actuator must not be higher than the maximum permissible torque listed in ISO 5211 in relation to the size of the mounting flange and of the coupling.

Data sheet

Theoretical torque [Nm] as a function of operating pressure [bar] and swivel angle [°]													
Spring configuration	Nominal swivel angle	Spring torque [Nm]	Operating pressure [bar]										
	[°]		2	2.5	3	3.5	4	4.5	5	5.5	6	7	8
Size DFPD-160													
20	0	19.2	39.3	53.9	68.6	83.2	97.9	112.5	127.1	141.8	156.4	185.7	214.9
	90	38.1	20.5	35.1	49.7	64.4	79.0	93.6	108.3	122.9	137.6	166.8	196.1
25	0	24.1	34.5	49.1	63.8	78.4	93.0	107.7	122.3	137.0	151.6	180.9	210.1
	90	47.6	37.6	25.6	40.2	54.9	69.5	84.1	98.8	113.4	128.0	157.3	186.6
30	0	28.9		44.3	59.0	73.6	88.2	102.9	117.5	132.1	146.8	176.0	205.3
	90	57.1		16.1	30.7	45.3	60.0	74.6	89.2	103.9	118.5	147.8	177.1
35	0	33.7			54.1	68.8	83.4	98.1	112.7	127.3	142.0	171.2	200.5
	90	66.6			21.2	35.8	50.4	65.1	79.7	94.4	109.0	138.3	167.5
40	0	38.5				64.0	78.6	93.2	107.9	122.5	137.2	166.4	195.7
	90	76.2				26.3	40.9	55.6	70.2	84.8	99.5	128.7	158.0
45	0	43.3					73.8	88.4	103.1	117.7	132.3	161.6	190.9
	90	85.7					31.4	46.0	60.7	75.3	90.0	119.2	148.5
50	0	48.1						83.6	98.3	112.9	127.5	156.8	186.1
	90	95.2						36.5	51.2	65.8	80.4	109.7	139.0
55	0	52.9							93.5	108.1	122.7	152.0	181.3
	90	104.7							41.6	56.3	70.9	100.2	129.5
60	0	57.7								103.3	117.9	147.2	176.5
	90	114.2								46.8	61.4	90.7	119.9
Size DFPD-240													
20	0	28.0	57.2	78.5	99.8	121.1	142.4	163.7	185.0	206.3	227.6	270.2	312.8
	90	55.4	29.8	51.1	72.4	93.7	115.0	136.3	157.6	178.9	200.2	242.8	285.4
25	0	35.0	50.2	71.5	92.8	114.1	135.4	156.7	178.0	199.3	220.6	263.2	305.8
	90	69.2	16.0	37.3	58.6	79.9	101.2	122.5	143.8	165.1	186.4	229.0	271.6
30	0	42.0		64.5	85.8	107.1	128.4	149.7	171.0	192.3	213.6	256.2	298.8
	90	83.0		23.5	44.8	66.1	87.4	108.7	130.0	151.3	172.6	215.2	257.8
35	0	49.0			78.8	100.1	121.4	142.7	164.0	185.3	206.6	249.2	291.8
	90	96.9			30.9	52.2	73.5	94.8	116.1	137.5	158.7	201.3	243.9
40	0	56.0				93.1	114.4	135.7	157.0	178.3	199.6	242.2	284.8
	90	110.7				38.4	59.7	81.0	102.3	123.6	144.9	187.5	230.1
45	0	63.0					107.4	128.7	150.0	171.3	192.6	235.2	277.8
	90	124.6					45.8	67.1	88.4	109.7	131.0	173.6	216.2
50	0	70.0						121.7	143.0	164.3	185.6	228.2	270.8
	90	138.4						53.3	74.6	95.9	117.2	159.8	202.4
55	0	77.0							136.0	157.3	178.6	221.2	263.8
	90	152.2							60.8	82.1	103.4	146.0	188.6
60	0	84.0								150.3	171.6	214.2	256.8
	90	166.1								68.2	89.5	132.1	174.7

 **Note**
 The operating torque of the actuator must not be higher than the maximum permissible torque listed in ISO 5211 in relation to the size of the mounting flange and of the coupling.

Data sheet

Theoretical torque [Nm] as a function of operating pressure [bar] and swivel angle [°]													
Spring configuration	Nominal swivel angle	Spring torque	Operating pressure [bar]										
	[°]		[Nm]	2	2.5	3	3.5	4	4.5	5	5.5	6	7
Size DFPD-300													
20	0	36.1	73.7	101.1	128.6	156.0	183.4	210.9	238.3	265.8	293.2	348.1	403.0
	90	71.4	38.4	65.9	93.3	120.8	148.2	175.6	203.1	230.5	258.0	312.9	367.8
25	0	45.2	64.6	92.1	119.5	147.0	174.4	201.9	229.3	256.8	284.2	339.1	394.0
	90	89.2	20.6	48.0	75.5	102.9	130.4	157.8	185.3	212.7	240.1	295.0	349.9
30	0	54.2		83.0	110.5	137.9	165.4	192.8	220.3	247.7	275.2	330.1	384.9
	90	107.0		30.2	57.6	85.1	112.5	140.0	167.4	194.9	222.3	277.2	332.1
35	0	63.2			101.5	128.9	156.4	183.8	211.2	238.7	266.1	321.0	375.9
	90	124.9			39.8	67.2	94.7	122.1	149.6	177.0	204.5	259.4	314.2
40	0	72.2				119.9	147.3	174.8	202.2	229.7	257.1	312.0	366.9
	90	142.7				49.4	76.8	104.3	131.7	159.2	186.6	241.5	296.4
45	0	81.3					138.3	165.7	193.2	220.6	248.1	303.0	357.9
	90	160.6					59.0	86.4	113.9	141.3	168.8	223.7	278.6
50	0	90.3						156.7	184.2	211.6	239.0	293.9	348.8
	90	178.4						68.6	96.1	123.5	150.9	205.8	260.7
55	0	99.3							175.1	202.6	230.0	284.9	339.8
	90	196.2							78.2	105.7	133.1	188.0	242.9
60	0	108.4								193.5	221.0	275.9	330.8
	90	214.1								87.8	115.3	170.2	225.0
Size DFPD-480													
20	0	56.7	115.7	158.8	201.9	245.0	288.0	331.1	374.2	417.3	460.4	546.6	632.8
	90	112.0	60.3	103.4	146.5	189.6	232.7	275.8	318.9	362.0	405.1	491.2	577.4
25	0	70.9	101.5	144.6	187.7	230.8	273.9	317.0	360.1	403.2	446.2	532.4	618.6
	90	140.1	32.3	75.4	118.5	161.6	204.7	247.8	290.9	334.0	377.0	463.2	549.4
30	0	85.0		130.4	173.5	216.6	259.7	302.8	345.9	389.0	432.1	518.3	604.4
	90	168.1		47.4	90.5	133.6	176.7	219.8	262.8	305.9	349.0	435.2	521.4
35	0	99.2			159.4	202.4	245.5	288.6	331.7	374.8	417.9	504.1	590.3
	90	196.1			62.5	105.6	148.7	191.7	234.8	277.9	321.0	407.2	493.4
40	0	113.4				188.3	231.4	274.5	317.5	360.6	403.7	489.9	576.1
	90	224.1				77.6	120.6	163.7	206.8	249.9	293.0	379.2	465.4
45	0	127.5					217.2	260.3	303.4	346.5	389.6	475.7	561.9
	90	252.1					92.6	135.7	178.8	221.9	265.0	351.2	437.4
50	0	141.7						246.1	289.2	332.3	375.4	461.6	547.8
	90	280.1						107.1	150.8	193.9	237.0	323.2	409.4
55	0	155.9							275.0	318.1	361.2	447.4	533.6
	90	308.1							122.8	165.9	209.0	295.2	381.3
60	0	170.0								304.0	347.1	433.2	519.4
	90	336.1								137.9	181.0	267.2	353.3

 - Note

The operating torque of the actuator must not be higher than the maximum permissible torque listed in ISO 5211 in relation to the size of the mounting flange and of the coupling.

Data sheet

Theoretical torque [Nm] as a function of operating pressure [bar] and swivel angle [°]														
Spring configuration	Nominal swivel angle	Spring torque [Nm]	Operating pressure [bar]											
	[°]		2	2.5	3	3.5	4	4.5	5	5.5	6	7	8	
Size DFPD-700														
20	0	78.8	162.4	222.7	283.0	343.3	403.6	463.9	524.2	584.5	644.8	705.1	765.4	825.7
	90	143.7	97.5	157.8	218.1	278.4	338.7	399.0	459.3	519.6	579.9	640.2	700.5	760.8
25	0	99.6	141.6	201.9	262.2	322.5	382.8	443.1	503.4	563.7	624.0	684.3	744.6	804.9
	90	181.7	59.5	119.8	180.1	240.4	300.7	361.0	421.3	481.6	541.9	602.2	662.5	722.8
30	0	120.9		180.6	240.9	301.2	361.5	421.8	482.1	542.4	602.7	663.0	723.3	783.6
	90	220.5		81.0	141.3	201.6	261.9	322.2	382.5	442.8	503.1	563.4	623.7	684.0
35	0	142.6			219.2	279.5	339.8	400.1	460.4	520.7	581.0	641.3	701.6	761.9
	90	260.1			101.6	161.9	222.2	282.5	342.8	403.1	463.4	523.7	584.0	644.3
40	0	164.8				257.3	317.6	377.9	438.2	498.5	558.8	619.1	679.4	739.7
	90	300.6				121.5	181.8	242.1	302.4	362.7	423.0	483.3	543.6	603.9
45	0	187.4					295.0	355.3	415.6	475.9	536.2	596.5	656.8	717.1
	90	341.9					140.5	200.8	261.1	321.4	381.7	442.0	502.3	562.6
50	0	210.5						332.2	392.5	452.8	513.1	573.4	633.7	694.0
	90	384.0						158.7	219.0	279.3	339.6	399.9	460.2	520.5
55	0	234.1							368.9	429.2	489.5	549.8	610.1	670.4
	90	427.0							176.0	236.3	296.6	356.9	417.2	477.5
60	0	258.1								405.2	465.5	525.8	586.1	646.4
	90	470.7								192.5	252.8	313.1	373.4	433.7
Size DFPD-900														
20	0	99.2	206.9	283.5	360.0	436.6	513.1	589.7	666.2	742.8	819.3	895.8	972.4	1048.9
	90	181.6	124.6	201.1	277.6	354.2	430.7	507.3	583.8	660.4	736.9	813.5	890.0	966.5
25	0	125.5	180.7	257.3	333.8	410.3	486.9	563.4	640.0	716.5	793.1	869.6	946.2	1022.7
	90	229.6	76.5	153.1	229.6	306.2	382.7	459.3	535.8	612.4	688.9	765.4	842.0	918.5
30	0	152.3		230.5	307.0	383.5	460.1	536.6	613.2	689.7	766.3	842.8	919.4	995.9
	90	278.7		104.0	180.6	257.1	333.7	410.2	486.8	563.3	639.8	716.4	792.9	869.4
35	0	179.6			279.6	356.2	432.7	509.3	585.8	662.3	738.9	815.4	891.9	968.4
	90	328.8			130.5	207.0	283.6	360.1	436.7	513.2	589.7	666.2	742.7	819.2
40	0	207.6				328.2	404.8	481.3	557.9	634.4	710.9	787.4	863.9	940.4
	90	379.9				155.9	232.4	309.0	385.5	462.1	538.6	615.1	691.6	768.1
45	0	236.1					376.2	452.8	529.3	605.9	682.4	758.9	835.4	911.9
	90	432.1					180.2	256.8	333.3	409.9	486.4	562.9	639.4	715.9
50	0	265.2						423.7	500.3	576.8	653.3	729.8	806.3	882.8
	90	485.4						203.5	280.1	356.6	433.2	509.7	586.2	662.7
55	0	294.8							470.6	547.1	623.7	700.2	776.7	853.2
	90	539.6							225.8	302.4	378.9	455.4	531.9	608.4
60	0	325.1								516.9	593.5	670.0	746.5	823.0
	90	595.0								247.0	323.6	400.1	476.7	553.2

 **Note**
 The operating torque of the actuator must not be higher than the maximum permissible torque listed in ISO 5211 in relation to the size of the mounting flange and of the coupling.

Data sheet

Theoretical torque [Nm] as a function of operating pressure [bar] and swivel angle [°]													
Spring configuration	Nominal swivel angle	Spring torque [Nm]	Operating pressure [bar]										
	[°]		2	2.5	3	3.5	4	4.5	5	5.5	6	7	8
Size DFPD-1200													
20	0	146.4	278.9	385.2	491.5	597.8	704.1	810.5	916.8	1023.1	1129.4	1342	1554
	90	243.8	181.5	287.8	394.1	500.4	606.7	713.0	819.3	925.7	1032.0	1244	1457
25	0	185.0	240.2	346.5	452.8	559.1	665.4	771.8	878.1	984.4	1090.7	1303	1515
	90	308.2	117.0	223.3	329.7	436.0	542.3	648.6	754.9	861.2	967.5	1180	1392
30	0	224.6		307.0	413.3	519.6	625.9	732.2	838.5	944.9	1051.2	1263	1476
	90	374.1		157.5	263.8	370.1	476.4	582.7	689.1	795.4	901.7	1114	1326
35	0	264.9			372.9	479.2	585.5	691.9	798.2	904.5	1010.8	1223	1436
	90	441.3			196.6	302.9	409.2	515.5	621.8	728.1	834.4	1047	1259
40	0	306.2				438.0	544.3	650.6	757.0	863.3	969.6	1182	1394
	90	510.0				234.2	340.5	446.8	553.2	659.5	765.8	978.4	1191
45	0	348.2					502.3	608.6	714.9	821.2	927.5	1140	1352
	90	580.0					270.5	376.8	483.1	589.4	695.7	908.4	1121
50	0	391.1						565.7	672.0	778.3	884.6	1097	1309
	90	651.5						305.3	411.7	518.0	624.3	836.9	1049
55	0	434.9							628.3	734.6	840.9	1053	1266
	90	724.3							338.8	445.1	551.4	764.1	976.7
60	0	479.4								690.0	796.3	1008	1221
	90	798.6								370.9	477.2	689.8	902.4
Size DFPD-2300													
20	0	278.8	533.3	736.3	939.4	1142	1345	1548	1751	1954	2157	2563	2969
	90	473.5	338.6	541.6	744.7	947.7	1150	1353	1556	1759	1962	2368	2774
25	0	352.5	459.6	662.6	865.7	1068	1271	1474	1677	1880	2083	2489	2895
	90	598.7	213.4	416.4	619.5	822.5	1025	1228	1431	1634	1837	2243	2649
30	0	427.8		587.3	790.4	993.4	1196	1399	1602	1805	2008	2414	2820
	90	726.6		288.5	491.6	694.6	897.6	1100	1303	1506	1709	2115	2521
35	0	504.7			713.5	916.5	1119	1322	1525	1728	1931	2337	2743
	90	857.2			361.0	564.0	767.0	970.0	1173	1376	1579	1985	2391
40	0	583.2				838.0	1041	1244	1447	1650	1853	2259	2665
	90	990.5				430.6	633.7	836.7	1039	1242	1445	1851	2257
45	0	663.3					960.9	1163	1367	1570	1773	2179	2585
	90	1127					497.6	700.6	903.6	1106	1309	1715	2121
50	0	745.0						1082	1285	1488	1691	2097	2503
	90	1265						561.8	764.9	967.9	1170	1577	1983
55	0	828.3							1201	1405	1608	2014	2420
	90	1407							623.4	826.4	1029	1435	1841
60	0	913.2								1320	1523	1929	2335
	90	1551								682.2	885.2	1291	1697

 - Note

The operating torque of the actuator must not be higher than the maximum permissible torque listed in ISO 5211 in relation to the size of the mounting flange and of the coupling.

Data sheet

Dimensions

Download CAD data → www.festo.com

Size: 10 ... 480

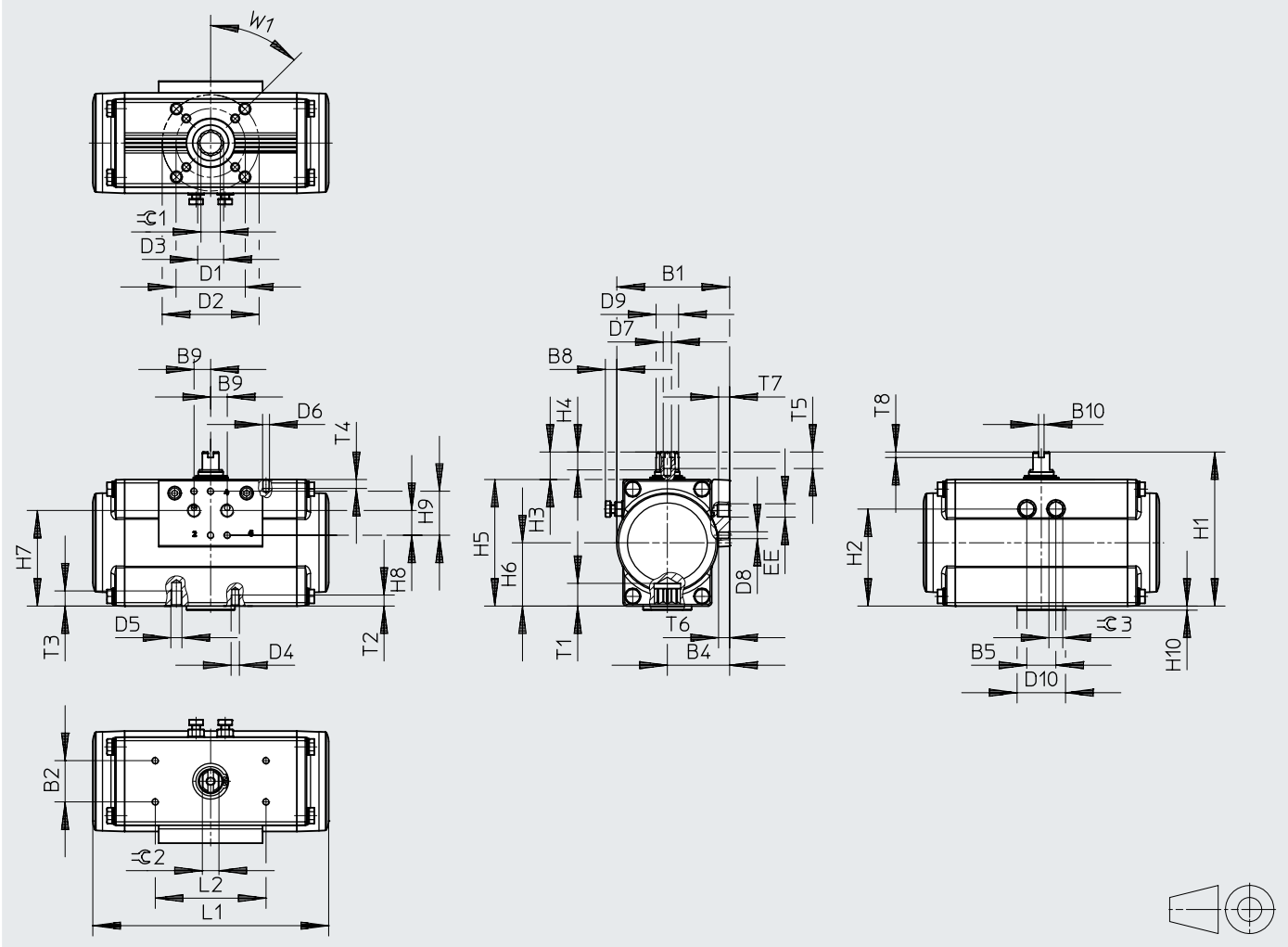

Data sheet

Type	B1	B2	B4	B5	B8	B9	B10	D1 ∅	D2 ∅	D3 ∅	D4	D5	D6	D7		
[mm]		±0.1														
DFPD-20-...-F03	68.5	30	38.5	19	9.2	12	4	36	-	12	M5	-	M5	M6		
DFPD-20-...-F04								42		14.6						
DFPD-20-...-F05								50								
DFPD-40-...-F0407	81.5		45	21	8.2			42	18.7	M6	M8					
DFPD-40-...-F0507			53	26	9											
DFPD-80-...-F0507	99		60.5	32	12.3			50	70	23.2	M8				M10	
DFPD-120-...-F0507	111.5		63.5	36	13.4											
DFPD-160-...-F0710	120		70	102	18.5			70	102	30	M8				M10	
DFPD-240-...-F0710	135.5															30.3
DFPD-300-...-F0710	144															30
DFPD-480-...-F1012	163	83	52	19.3	102	125	37.4	M10	M12							

Type	D8	D9 ∅	D10	EE	H1	H2	H3	H4	H5	H6	H7	H8	H9	H10				
[mm]							-0.5	+0.1				±0.1						
DFPD-20-...-F03	M5	12.7	-	G1/8 or 1/8 NPT	100	59.75	20	10	80	40	57.5	17	32	-				
DFPD-20-...-F04			30															
DFPD-20-...-F05			-															
DFPD-40-...-F0407		16.2	35	112	70.5	13		92	46	67.5								
DFPD-40-...-F0507																		
DFPD-80-...-F0507		20.2	55	143	97.75	19.5		110	55	86.5	18							
DFPD-120-...-F0507		22.5										G1/4 or 1/4 NPT		154	106.25	123	61.5	98.4
DFPD-160-...-F0710		25.5																
DFPD-240-...-F0710		31.8	70	180	120.5	30		150	75	120.2	16							
DFPD-300-...-F0710												192		131				
DFPD-480-...-F1012	38	85	214	149.5	184	92	152.5											

Type	L1	L2	T1	T2	T3	T4	T5	T6	T7	T8	W1	⊖ 1	⊖ 2	⊖ 3
[mm]			min.	min.	min.	min.	min.		min.	+0.5		H11	h11	
DFPD-20-...-F03	145.7	80	10	8	-	8	12	8	8	4	45°	9	9	10
DFPD-20-...-F04			12	9								11		
DFPD-20-...-F05			8	8								14		
DFPD-40-...-F0407	170.4		16	9	12			17	15	13				
DFPD-40-...-F0507			19	19										
DFPD-80-...-F0507	233.1		24	12	15			22	22	16				
DFPD-120-...-F0507	252.3											29	15	18
DFPD-160-...-F0710	270.9													
DFPD-240-...-F0710	301.4		27	27	21									
DFPD-300-...-F0710	334.4													
DFPD-480-...-F1012	374.2													

Data sheet

Dimensions

Download CAD data → www.festo.com

Size: 700 ... 2300

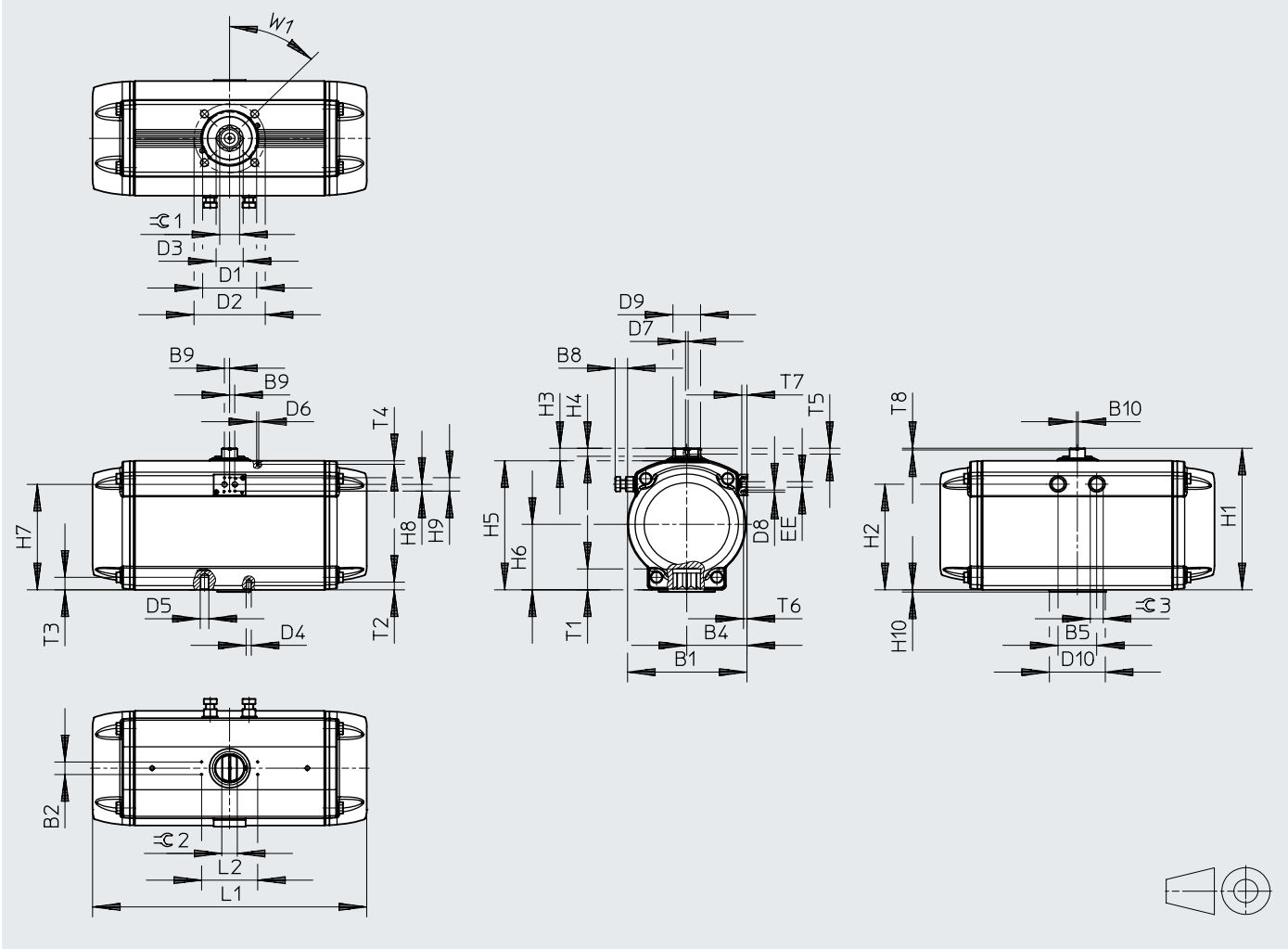

Data sheet

Type	B1	B2	B4	B5	B8	B9	B10	D1 ∅	D2 ∅	D3 ∅	D4	D5	D6	D7
[mm]		±0.1			max.		±0.1							
DFPD-700-...-F1012	184	30	93	57.6	17.5	12	4	102	125	37.4	M10	M12	M5	M6
DFPD-900-...-F1012	202		102	64.8	28.6			140	-	50.1	M16	-		
DFPD-900-...-F14			102	125	37.4			M10	M12					
DFPD-1200-...-F1012	221.5		111.5	72	24			140	-	50.1	M16	-		
DFPD-1200-...-F14			125	165	62.9			M12	M20					
DFPD-2300-...-F1216	277		139.8	90	33			140	-	50.1	M16	-		
DFPD-2300-...-F14								165	-	62.9	M20	-		
DFPD-2300-...-F16														

Type	D8	D9 ∅	D10 ∅	EE	H1	H2	H3	H4	H5	H6	H7	H8	H9	H10							
[mm]		±0.1	max.				-0.5					±0.1									
DFPD-700-...-F1012	M5	41	85	G1/4 or 1/4NPT	232.7	168	30	21	203	103	164.9	16	32	3							
DFPD-900-...-F1012		44	100		252.7	182			223	113	178.3			4							
DFPD-900-...-F14		50			275.7	204			246	125	199.6										
DFPD-1200-...-F1012		64	-		338.7	253			19	309	157			252.3	-						
DFPD-1200-...-F14								130								-	-	-	-	-	-
DFPD-2300-...-F1216																					
DFPD-2300-...-F14																					

Type	L1	L2	T1	T2	T4	T5	T6	T7	T8	≙ 1	≙ 2	≙ 3	W1
[mm]		±0.1	min.						+0.4	H11	h11		
DFPD-700-...-F1012	428.2	80	29.7	15	8	14	8	12	4	27	30	21	45°
DFPD-900-...-F1012	469.6	130	30.2	15.5	32						24		
DFPD-900-...-F14			40.2	24.5	36								
DFPD-1200-...-F1012	519.3		31	15.5	27						36		
DFPD-1200-...-F14			40	24.5	36								
DFPD-2300-...-F1216	636		50	18.5	46						36	30	
DFPD-2300-...-F14			40	24.5	36								
DFPD-2300-...-F16			50	30	46								

Data sheet

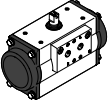
Ordering data				
Type	Size	Product weight [g]	Part no.	Type
	20	1399	8102796	DFPD-20-RP-90-RS45-F05-R3-C
		1383	8102797	DFPD-20-RP-90-RS35-F05-R3-C
		1423	8102798	DFPD-20-RP-90-RS60-F05-R3-C
	40	2108	8102802	DFPD-40-RP-90-RS35-F05-R3-C
		2139	8102803	DFPD-40-RP-90-RS45-F05-R3-C
		2185	8102804	DFPD-40-RP-90-RS60-F05-R3-C
	80	3792	8102809	DFPD-80-RP-90-RS35-F07-R3-C
		3863	8102810	DFPD-80-RP-90-RS45-F07-R3-C
		3970	8102811	DFPD-80-RP-90-RS60-F07-R3-C
		3785	8102815	DFPD-80-RP-90-RS35-F07-R3-C-VDE2
		3856	8102816	DFPD-80-RP-90-RS45-F07-R3-C-VDE2
		3963	8102817	DFPD-80-RP-90-RS60-F07-R3-C-VDE2
	120	5485	8102818	DFPD-120-RP-90-RS35-F07-R3-C
		5590	8102819	DFPD-120-RP-90-RS45-F07-R3-C
		5747	8102820	DFPD-120-RP-90-RS60-F07-R3-C
		5476	8102824	DFPD-120-RP-90-RS35-F07-R3-C-VDE2
		5581	8102825	DFPD-120-RP-90-RS45-F07-R3-C-VDE2
		5738	8102826	DFPD-120-RP-90-RS60-F07-R3-C-VDE2
	160	6863	8102832	DFPD-160-RP-90-RS35-F07-R3-C
		7000	8102833	DFPD-160-RP-90-RS45-F07-R3-C
		7206	8102834	DFPD-160-RP-90-RS60-F07-R3-C
		6853	8102838	DFPD-160-RP-90-RS35-F07-R3-C-VDE2
		6990	8102839	DFPD-160-RP-90-RS45-F07-R3-C-VDE2
		7196	8102840	DFPD-160-RP-90-RS60-F07-R3-C-VDE2
	240	9558	8102842	DFPD-240-RP-90-RS35-F10-R3-C
		9756	8102843	DFPD-240-RP-90-RS45-F10-R3-C
		10053	8102844	DFPD-240-RP-90-RS60-F10-R3-C
		9539	8102848	DFPD-240-RP-90-RS35-F10-R3-C-VDE2
		9737	8102849	DFPD-240-RP-90-RS45-F10-R3-C-VDE2
		10034	8102850	DFPD-240-RP-90-RS60-F10-R3-C-VDE2
	300	12209	8102851	DFPD-300-RP-90-RS35-F10-R3-C
		12485	8102852	DFPD-300-RP-90-RS45-F10-R3-C
		12899	8102853	DFPD-300-RP-90-RS60-F10-R3-C
		12187	8102857	DFPD-300-RP-90-RS35-F10-R3-C-VDE2
		12463	8102858	DFPD-300-RP-90-RS45-F10-R3-C-VDE2
		12877	8102859	DFPD-300-RP-90-RS60-F10-R3-C-VDE2
	480	17498	8102860	DFPD-480-RP-90-RS35-F12-R3-C
		17906	8102861	DFPD-480-RP-90-RS45-F12-R3-C
		18518	8102862	DFPD-480-RP-90-RS60-F12-R3-C
		17848	8102866	DFPD-480-RP-90-RS35-F12-R3-C-VDE2
		17892	8102867	DFPD-480-RP-90-RS45-F12-R3-C-VDE2
		18504	8102868	DFPD-480-RP-90-RS60-F12-R3-C-VDE2

Data sheet

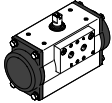
Ordering data				
Type	Size	Product weight [g]	Part no.	Type
	700	24723	8102879	DFPD-700-RP-90-RS35-F12-R3-C
		25357	8102880	DFPD-700-RP-90-RS45-F12-R3-C
		26308	8102881	DFPD-700-RP-90-RS60-F12-R3-C
		24708	8102885	DFPD-700-RP-90-RS35-F12-R3-C-VDE2
		25342	8102886	DFPD-700-RP-90-RS45-F12-R3-C-VDE2
		26293	8102887	DFPD-700-RP-90-RS60-F12-R3-C-VDE2
	900	28395	8102888	DFPD-900-RP-90-RS35-F14-R3-C
		29199	8102889	DFPD-900-RP-90-RS45-F14-R3-C
		30405	8102890	DFPD-900-RP-90-RS60-F14-R3-C
		28184	8102894	DFPD-900-RP-90-RS35-F14-R3-C-VDE2
		28988	8102895	DFPD-900-RP-90-RS45-F14-R3-C-VDE2
		30194	8102896	DFPD-900-RP-90-RS60-F14-R3-C-VDE2
	1200	40067	8102897	DFPD-1200-RP-90-RS35-F14-R3-C
		41240	8102898	DFPD-1200-RP-90-RS45-F14-R3-C
		43062	8102899	DFPD-1200-RP-90-RS60-F14-R3-C
		40042	8102903	DFPD-1200-RP-90-RS35-F14-R3-C-VDE2
		41240	8102904	DFPD-1200-RP-90-RS45-F14-R3-C-VDE2
		43037	8102905	DFPD-1200-RP-90-RS60-F14-R3-C-VDE2
	2300	72562	8102908	DFPD-2300-RP-90-RS35-F16-R3-C
		74726	8102909	DFPD-2300-RP-90-RS45-F16-R3-C
		77972	8102910	DFPD-2300-RP-90-RS60-F16-R3-C
72531		8102911	DFPD-2300-RP-90-RS35-F16-R3-C-VDE2	
74695		8102912	DFPD-2300-RP-90-RS45-F16-R3-C-VDE2	
77941		8102913	DFPD-2300-RP-90-RS60-F16-R3-C-VDE2	

Accessories

Dimensions

Download CAD data → www.festo.com

Control plate DADG-FM-F9-VDE2

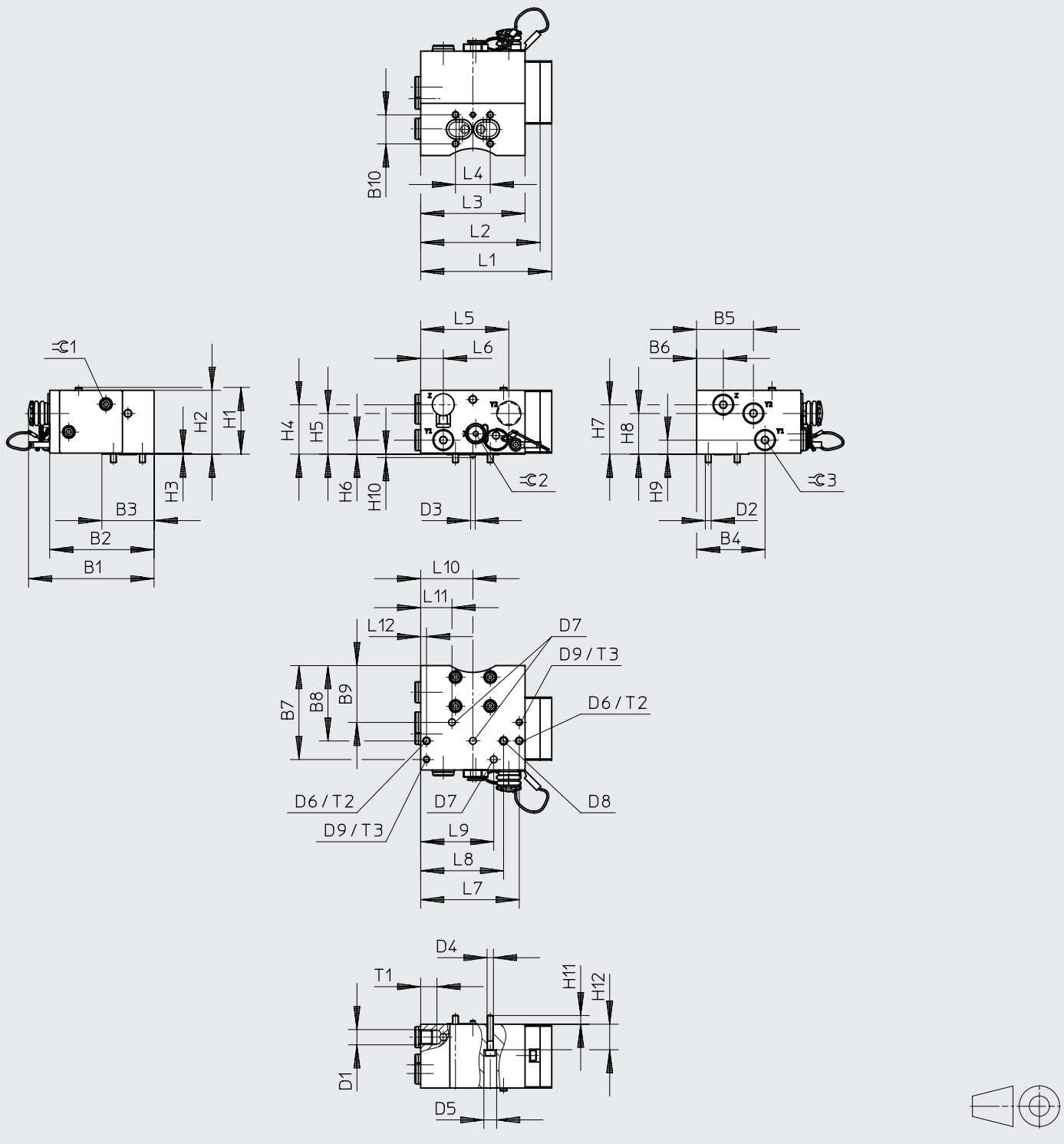

Accessories

Type	B1 max.	B2	B3	B4	B5	B6	B7	B8	B9	B10	D1	D2
DADG-FM-F9-VDE2	115	90	45	59	49	23	81	65	49	25	G1/4	M5

Type	D3 ∅ m6	D4 ∅	D5 ∅	D6	D7 ∅	D8 ∅ m6	D9	H1	H2	H3	H4	H5
DADG-FM-F9-VDE2	4	11	5.5	M6	6	6	M5	57.5	55	0.8	42.5	35

Type	H6	H7	H8	H9	H10	H11	H12	L1	L2	L3	L4	L5
DADG-FM-F9-VDE2	12	42.5	35	12	3	7.4	22	113	103	90	30	76

Type	L6	L7	L8	L9	L10	L11	T1	T2	T3	⊕ 1	⊕ 2	⊕ 2
DADG-FM-F9-VDE2	19.5	85	71.5	63	45	27	14	10	10	9	14	9

Ordering data – Control plate

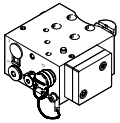
	Description	Part no.	Type
	For sizes 80 to 2300	8104802	DADG-FM-F9-VDE2

Accessories

Dimensions

Download CAD data → www.festo.com

Adapter kit DADG-FM-F9-VDE2

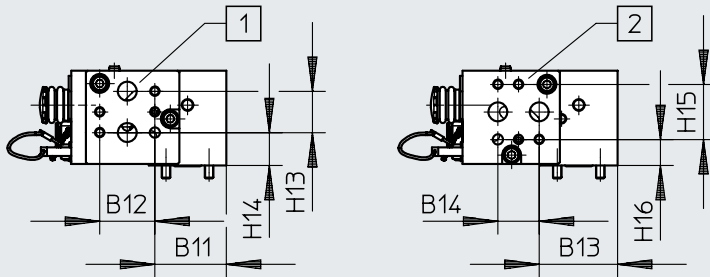

- [1] VDI/VDE 3845
- [2] VDI/VDE 3845 swivelled by 90°

Type	B11	B12	B13	B14	H13	H14	H15	H16
DADG-FM-F9-VDE2	41.5	32	45.5	24	24	19	32	14.8

Accessories

Dimensions

Download CAD data → www.festo.com

Adapter kit DADG-AK-F9-1

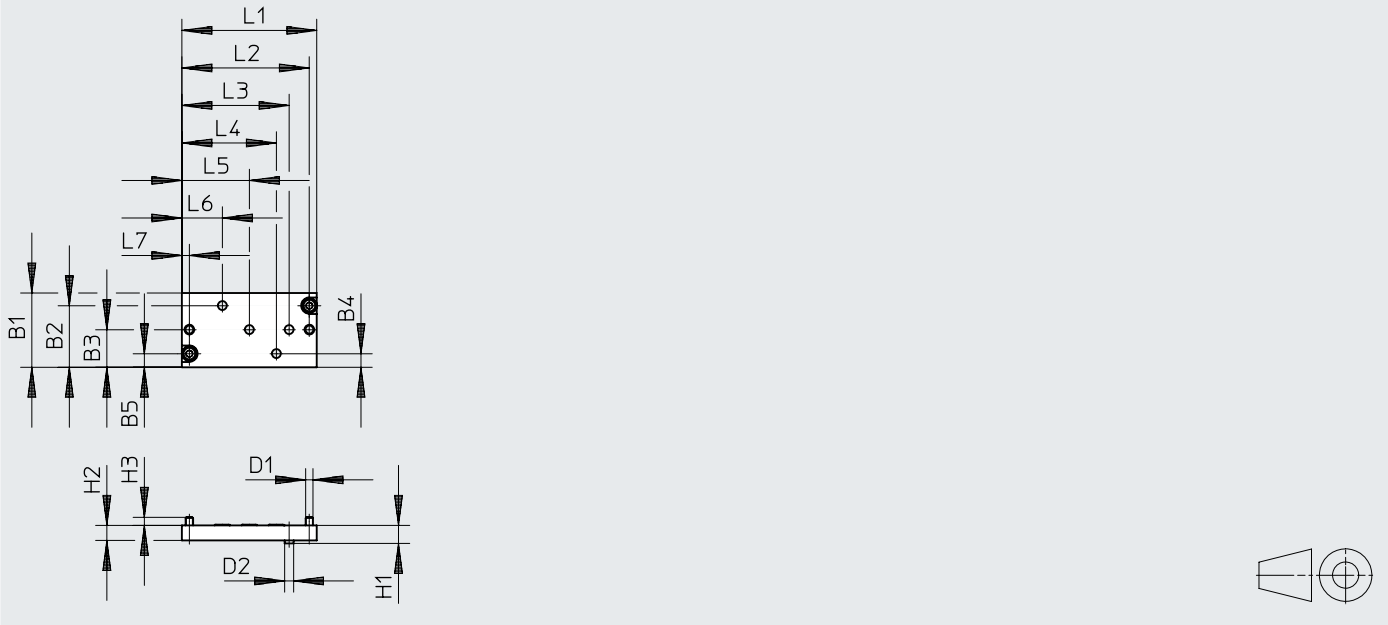

Type	B1	B2	B3	B4	B5	D1	D2 ∅	H1	H2
DADG-AK-F9-1	49.5	41	25	9	9	M5	6	12	10

Type	H3	L1	L2	L3	L4	L5	L6	L7
DADG-AK-F9-1	2	90	85	71.5	63	45	27	5

Ordering data – Adapter kit DADG-AK-F9-1

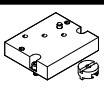
	Description	Part no.	Type
	For sizes 80 to 160 The VDI/VDE 3847-2 interface is increased of 10 mm	8125947	DADG-AK-F9-1

Accessories

Dimensions

Download CAD data → www.festo.com

Adapter kit DADG-AK-F9-2

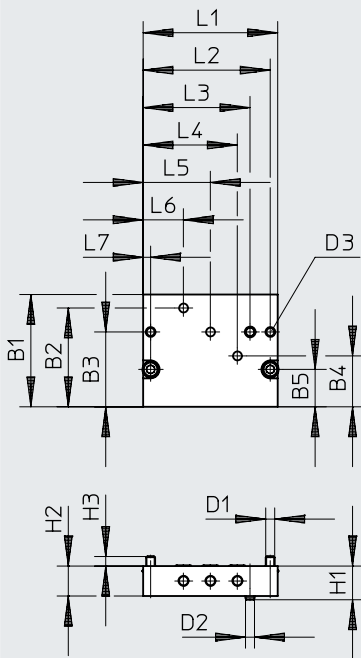

Type	B1	B2	B3	B4	B5	D1	D2 ∅ m6	D3	H1
DADG-AK-F9-2	75	66	50	34	25	M6	6	M6	22.5

Type	H2	H3	L1	L2	L3	L4	L5	L6	L7
DADG-AK-F9-2	20	6.3	90	85	71.5	63	45	27	5

Ordering data – Adapter kit DADG-AK-F9-2

	Description	Part no.	Type
	For size 2300 The VDI/VDE 3847-2 interface is increased of 10 mm	8104804	DADG-AK-F9-2

Accessories

Ordering data – Spring assembly							
Size	Pack size	Note on materials	Spring guide material	CRC ¹⁾	Weight [g]	Part no.	Type
20	100	RoHS-compliant	High-alloy stainless steel	0	7.8	8103224	DADG-FP-F9-20-R3-P100
40	100				16.5	8103225	DADG-FP-F9-40-R3-P100
80	100				33.3	8103226	DADG-FP-F9-80-R3-P100
120	100				52	8103227	DADG-FP-F9-120-R3-P100
160	100				65.8	8103228	DADG-FP-F9-160-R3-P100
240	100				93.8	8103229	DADG-FP-F9-240-R3-P100
300	100				127	8103230	DADG-FP-F9-300-R3-P100
480	100				198	8103231	DADG-FP-F9-480-R3-P100
700	50				316	8103232	DADG-FP-F9-700-R3-P50
900	50				399	8103233	DADG-FP-F9-900-R3-P50
1200	50				595	8103234	DADG-FP-F9-1200-R3-P50
2300	25				1083	8103235	DADG-FP-F9-2300-R3-P25

1) Corrosion resistance class CRC 0 to Festo standard FN 940070
 No corrosion stress. Applies to small, visually unimportant standard parts such as threaded pins, circlips and clamping sleeves which are usually only available on the market in a phosphated or burnished version (and possibly oiled) as well as to ball bearings (for components < CRC 3) and plain bearings.

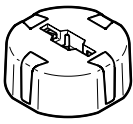
Position indicator SASF					
	Dimensions W x L x H	Ambient temperature	Product weight	Part no.	Type
	∅ 101 mm x 30 mm	-20 ... 80 °C	50 g	8147102	SASF-F9-DE-64-A30
	∅ 50 mm x 20 mm		16 g	8147095	SASF-F9-DE-25-A20
			17 g	8147090	SASF-F9-DE-12-A20
				8147091	SASF-F9-DE-16-A20
				8147092	SASF-F9-DE-19-A20
				8147093	SASF-F9-DE-20-A20
			8147094	SASF-F9-DE-22-A20	
	∅ 70 mm x 25 mm		26 g	8147101	SASF-F9-DE-50-A30
			27 g	8147100	SASF-F9-DE-44-A30
			28 g	8147099	SASF-F9-DE-41-A30
			29 g	8147098	SASF-F9-DE-38-A30
			30 g	8147096	SASF-F9-DE-31-A30