

■ Installation and application





- 1、 When load changes in the work, the cylinder with abundant output capacity shall be selected;
- 2、 Relative cylinder with high temperature resistance or corrosion resistance shall be chosen under the condition of high temperature or corrosion;
- 3、 Necessary protection measure shall be taken in the environment with larger humidity, much dust or water drops, oil dust and welding dregs;
- 4、 Dirty substances in the pipe must be cleared away before cylinder is connected with pipeline to prevent the entrance of sundries into the cylinder;
- 5、 The medium used by cylinder shall be filtered by the filter core of above 40um;
- 6、 As both of the front cover and piston of the cylinder are short, typically too large stroke can not be selected;
- 7、 Anti-freezing measure shall be adopted under low temperature environment to prevent moisture freezing;
- 8、 The cylinder shall avoid the influence of side load in operation to maintain the normal work of cylinder and extend the service life;
- 9、 If the cylinder is dismantled and stored for a long time, please conduct anti-rust treatment to the surface.
Anti-dust jam cap shall be added in air intake and outlet orifices. The front and back cover can not be dismantled, which shall be especially noticed.

■ Criteria for selection: Cylinder thrust

Unit: Newton (N)

Bore size(mm)	Rod size (mm)	Acting type	Pressure area(mm ²)	Operating pressure MPa							
				0.1	0.2	0.3	0.4	0.5	0.6	0.7	
12	6	Single acting-Push type	113.1	-	12.6	23.9	35.2	46.5	57.9	69.2	
		Single acting-Pull type	84.8	-	7.0	15.4	23.9	32.4	40.9	49.4	
		Double acting	Push side	113.1	-	22.6	33.9	45.2	56.5	67.9	79.2
			Pull side	84.8	-	17.0	25.4	33.9	42.4	50.9	59.4
16	6	Single acting-Push type	201.1	-	20.2	40.3	60.4	80.5	100.6	120.7	
		Single acting-Pull type	172.8	-	14.6	31.8	49.1	66.4	83.7	101.0	
		Double acting	Push side	201.1	-	40.2	60.3	80.4	100.5	120.6	140.7
			Pull side	172.8	-	34.6	51.8	69.1	86.4	103.7	121.0
20	8	Single acting-Push type	314.2	-	39.8	71.2	102.7	134.1	165.5	196.9	
		Single acting-Pull type	263.9	-	29.8	56.2	82.6	108.9	135.3	161.7	
		Double acting	Push side	314.2	-	62.8	94.2	125.7	157.1	188.5	219.9
			Pull side	263.9	-	52.8	79.2	105.6	131.9	158.3	184.7
25	10	Single acting-Push type	490.9	-	69.7	118.8	167.8	216.9	266.0	315.1	
		Single acting-Pull type	412.3	-	54.0	95.2	136.4	177.7	218.9	260.1	
		Double acting	Push side	490.9	-	98.2	147.3	196.3	245.4	294.5	343.6
			Pull side	412.3	-	82.5	123.7	164.9	206.2	247.4	288.6
32	12	Single acting-Push type	804.2	-	105.3	185.8	266.2	346.6	427.0	507.5	
		Single acting-Pull type	691.2	-	82.7	151.8	221.0	290.1	359.2	428.3	
		Double acting	Push side	804.2	-	160.8	241.3	321.7	402.1	482.5	563.0
			Pull side	691.2	-	138.2	207.3	276.5	345.6	414.7	483.8
40	16	Single acting-Push type	1256.6	-	168.6	294.3	420.0	545.6	671.3	796.9	
		Single acting-Pull type	1055.6	-	128.4	234.0	339.5	445.1	550.6	656.2	
		Double acting	Push side	1256.6	125.7	251.3	377.0	502.7	628.3	754.0	879.6
			Pull side	1055.6	105.6	211.1	316.7	422.2	527.8	633.3	738.9
50	20	Single acting-Push type	1963.5	89.3	285.7	482.0	678.4	874.7	1071.1	1267.4	
		Single acting-Pull type	1649.3	57.9	222.9	387.8	552.7	717.7	882.6	1047.5	
		Double acting	Push side	1963.5	196.3	392.7	589.0	785.4	981.7	1178.1	1374.4
			Pull side	1649.3	164.9	329.9	494.8	659.7	824.7	989.6	1154.5
63	20	Single acting-Push type	3117.2	135.7	447.4	759.2	1070.9	1382.6	1694.3	2006.1	
		Single acting-Pull type	2803.1	104.3	384.6	664.9	945.2	1225.5	1505.9	1786.2	
		Double acting	Push side	3117.2	311.7	623.4	935.2	1246.9	1558.6	1870.3	2182.1
			Pull side	2803.1	280.3	560.6	840.9	1121.2	1401.5	1681.9	1962.2
80	25	Double acting	Push side	5026.5	502.7	1005.3	1508.0	2010.6	2513.3	3015.9	3518.6
		Pull side	4535.7	453.6	907.1	1360.7	1814.3	2267.8	2721.4	3175.0	
100	32	Double acting	Push side	7854.0	785.4	1570.8	2356.2	3141.6	3927.0	4712.4	5497.8
		Pull side	7049.7	705.0	1409.9	2114.9	2819.9	3524.9	4229.8	4934.8	

■ Product series

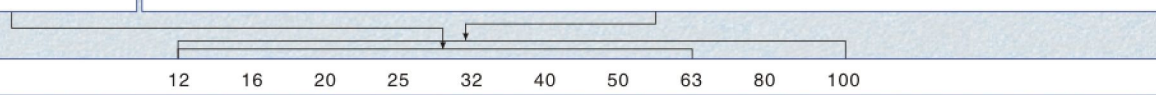
Series name	Single acting type: SSA, STA	Double rod type: SDAD	Adjustable stroke type: SDAJ	Duplex type: SDAT Duplex-end type: SDAW	Double acting type: SDA	Page	
						V-16	
Acting type	Single acting		Double acting				
Bore size							
Collocation of sensor switch	CS1-J CS1-JX CS1-JN CS1-JP CS1-G CS1-GX CS1-GN CS1-GP					VI-39	

SDA Series

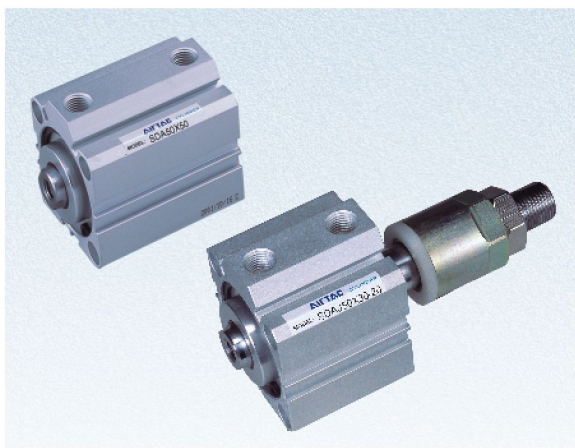

Symbol

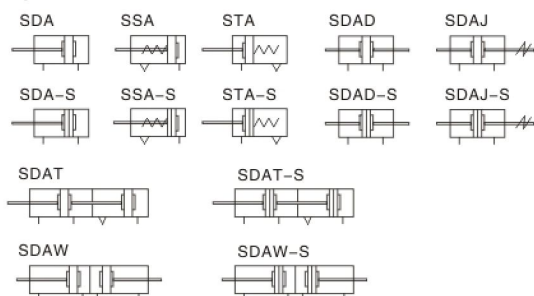

Product feature

- 1、Manufactured by our enterprise;
- 2、Riveted structure is adopted to connect the cylinder body and back cover, and piston and piston rod to make it compact and reliable;
- 3、The inner diameter of the body is treated with rolling followed by the treatment of hard anodizing, forming an excellent abrasion resistance and durability;
- 4、The seal of piston adopts heterogeneous two-way seal structure. It has compact dimension and the function of oil reservation;
- 5、Compact structure can effectively save installation space;
- 6、There are magnetic switch slots around the cylinder body, which is convenient to install sensor switch;
- 7、Mounting accessories with various specifications are optional.

Specification

Bore size (mm)		12	16	20	25	32	40	50	63	80	100	
Acting type	Double acting type											
	Single acting-Push type、Single acting-Pull type										-	
Fluid		Air(to be filtered by 40um filter element)										
Operating pressure	Double acting	0.1-1.0MPa(14-145Psi)										
	Single acting	0.2-1.0MPa(28-145Psi)										
Proof pressure		1.5MPa(215Psi)										
Temperature °C		-20-80										
Speed range mm/s		Double acting type: 30-500					Single acting type: 50-500					
Stroke tolerance		+1.0 0										
Cushion type		Bumper										
Port size ①		M5 × 0.8				1/8"		1/4"		3/8"		

① PT thread, NPT thread and G thread are available;
Add: Refer to PVI-39-VI-50 for detail of sensor switch.

Stroke

Bore size (mm)		Standard stroke (mm)										Max. stroke	Available stroke													
12 16	Double acting	With magnet	5	10	15	20	25	30	35	40	45	50	55	65	70											
		Without magnet	5	10	15	20	25	30	35	40	45	50	55	60	65	65	80									
	Single acting type	5	10	15	20	25	30	30	-																	
20	Double acting	With magnet	5	10	15	20	25	30	35	40	45	50	55	60	65	70	75	80	85	90	100	130				
		Without magnet	5	10	15	20	25	30	35	40	45	50	55	60	65	70	75	80	85	90	95	100	100	130		
	Single acting type	5	10	15	20	25	30	30	-																	
25 32 40 50	Double acting	With magnet	5	10	15	20	25	30	35	40	45	50	55	60	65	70	75	80	85	90	95	100	110	120	130	150
		Without magnet	5	10	15	20	25	30	35	40	45	50	55	60	65	70	75	80	85	90	95	100	110	120	130	130
	Single acting type	5	10	15	20	25	30	30	-																	
63	Double acting	With magnet	5	10	15	20	25	30	30	-																
		Without magnet	5	10	15	20	25	30	30	-																
80 100	Double acting	With magnet	5	10	15	20	25	30	35	40	45	50	55	60	65	70	75	80	85	90	95	100	110	120	130	150
		Without magnet	5	10	15	20	25	30	35	40	45	50	55	60	65	70	75	80	85	90	95	100	110	120	130	130

Note: 1、Within allowable stroke scope, when the stroke is larger than the maximum value, it shall be treated as non-standard one. Please contact the company for other special strokes.
2、The non-standard stroke within the scope of maximum stroke is transformed according to the standard stroke of the upper grade and its shape and dimension are equal to that of standard stroke cylinder of the upper grade. For instance, the non-standard stroke cylinder whose stroke is 23 is transformed from the standard cylinder whose standard stroke is 25, and their shape and dimension are the same.

Ordering code

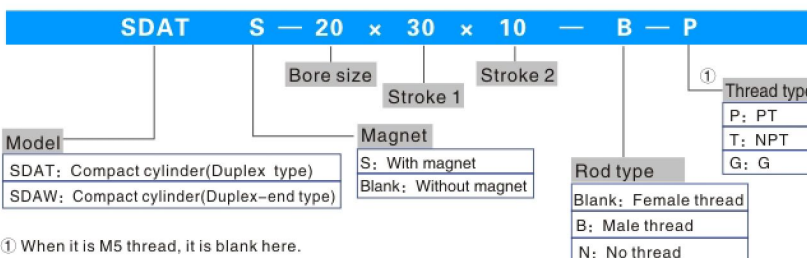
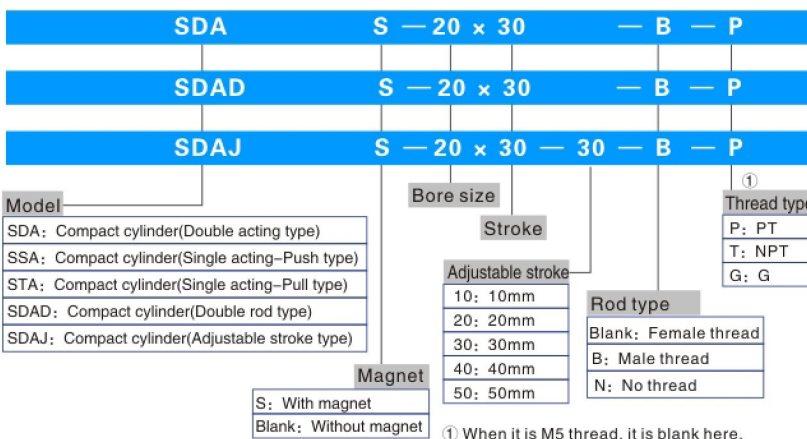

Inner structure and material of major parts

Dimensions

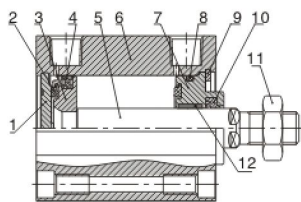

NO.	Item	Material			
		12、16	20	25-40	50-100
1	Back cover	-	Aluminum alloy		
2	Bumper	NBR			
3	Piston	Brass	Aluminum alloy		
4	Piston O-ring	NBR			
5	Piston rod	Carbon steel (with 20um hard chrome plated)			
6	Body	Aluminum alloy			
7	Front cover	Brass	Aluminum alloy		
8	O-ring	NBR			
9	C clip	Spring steel			
10	Front cover packing	NBR			
11	Piston nut	Carbon steel			
12	Bushing	-	Wear resistant material		

SDA

φ 12 φ 16

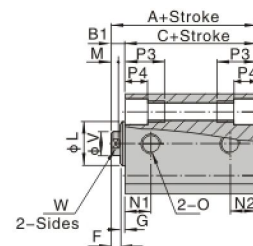
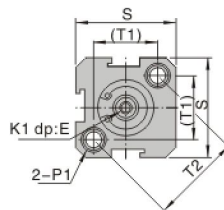

φ 20 ~ φ 100

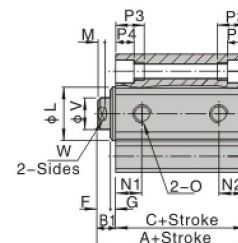
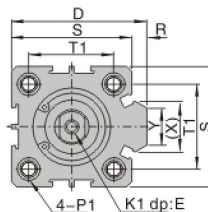

Model	Without magnet		With magnet		B1	D	E	F	G	K1	L	M	N1		N2	
	A	C	A	C									S=5	S>5	S=5	S>5
12	22	17	32	27	5	-	6	4	1	M3 × 0.5	10.2	3	7.5	5		
16	24	18.5	34	28.5	5.5	-	6	4	1.5	M3 × 0.5	11	3	8	5.5		
20	25	19.5	35	29.5	5.5	36	8	4	1.5	M4 × 0.7	13	3	9	5.5		
25	27	21	37	31	6	42	10	4	2	M5 × 0.8	17	3	9.2	5.5		
32	31.5	24.5	41.5	34.5	7	50	12	4	2.4	M6 × 1	22	3	9	6.5	9	
40	33	26	43	36	7	58.5	12	4	3	M8 × 1.25	28	3	9.5	7.5		
50	37	28	47	38	9	71.5	15	5	4	M10 × 1.5	38	3	8	10.5	8	10.5
63	41	32	51	42	9	84.5	15	5	4	M10 × 1.5	40	3	9.5	12	9.5	11
80	52	41	62	51	11	104	20	6	5	M14 × 1.5	45	4	11.5	14.5	11.5	14.5
100	63	51	73	61	12	124	20	7	5	M18 × 1.5	55	4	16	20.5	16	20.5

Bore size\Item	O	P1				P3	P4	R	S	T1	T2	V	W	X	Y
		2-Sides: φ 6.5	Thread: M5 × 0.8	Thru.hole: φ 4.2	Thru.hole: φ 4.2										
12	M5 × 0.8	2-Sides: φ 6.5	Thread: M5 × 0.8	Thru.hole: φ 4.2	12	4.5	-	25	16.3	23	6	5	-	-	
16	M5 × 0.8	2-Sides: φ 6.5	Thread: M5 × 0.8	Thru.hole: φ 4.2	12	4.5	-	29	19.8	28	6	5	-	-	
20	M5 × 0.8	2-Sides: φ 6.5	Thread: M5 × 0.8	Thru.hole: φ 4.2	14	4.5	2	34	24	-	8	6	11.3	10	
25	M5 × 0.8	2-Sides: φ 8.2	Thread: M6 × 1.0	Thru.hole: φ 4.6	15	5.5	2	40	28	-	10	8	12	10	
32	1/8"	2-Sides: φ 8.2	Thread: M6 × 1.0	Thru.hole: φ 4.6	16	5.5	6	44	34	-	12	10	18.3	15	
40	1/8"	2-Sides: φ 10	Thread: M8 × 1.25	Thru.hole: φ 6.5	20	7.5	6.5	52	40	-	16	14	21.3	16	
50	1/4"	2-Sides: φ 11	Thread: M8 × 1.25	Thru.hole: φ 6.5	25	8.5	9.5	62	48	-	20	17	30	20	
63	1/4"	2-Sides: φ 11	Thread: M8 × 1.25	Thru.hole: φ 6.5	25	8.5	9.5	75	60	-	20	17	28.7	20	
80	3/8"	2-Sides: φ 14	Thread: M12 × 1.75	Thru.hole: φ 9.2	25	10.5	10	94	74	-	25	22	36	26	
100	3/8"	2-Sides: φ 17.5	Thread: M14 × 2	Thru.hole: φ 11.3	30	13	10	114	90	-	32	27	35	26	

SDA Series

SSA

φ 12 φ 16

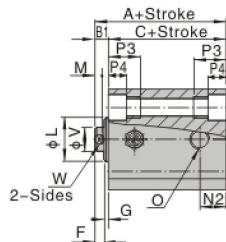
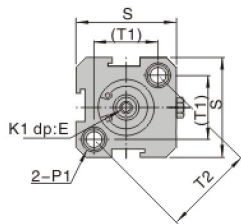

φ 20 - φ 63

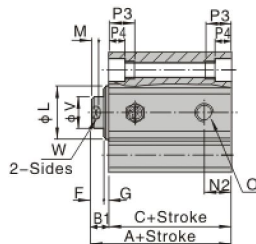
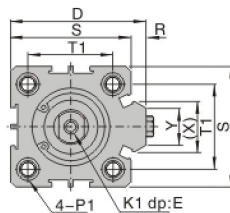

STA

φ 12 φ 16

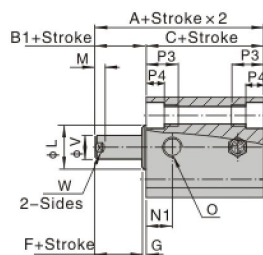
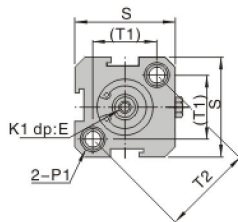

φ 20 - φ 63

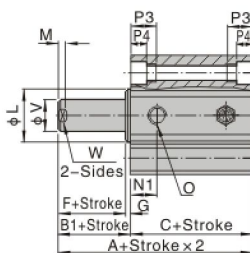
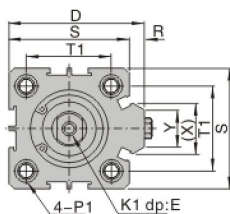

Model	Without magnet				With magnet			
	A		C		A		C	
Bore size\Item	≤10	>10	≤10	>10	≤10	>10	≤10	>10
Stroke	12	32	42	27	37	42	52	37
	16	34	44	28.5	38.5	44	54	38.5
	20	35	45	29.5	39.5	45	55	39.5
	25	37	47	31	41	47	57	41
	32	41.5	51.5	34.5	44.5	51.5	61.5	44.5
	40	43	53	36	46	53	63	46
	50	47	57	38	48	57	67	48
	63	51	61	42	52	61	71	52

Bore size\Item	B1	D	E	F	G	K1	L	M	N1	N2
12	5	-	6	4	1	M3 × 0.5	10.2	3	7.5	5
16	5.5	-	6	4	1.5	M3 × 0.5	11	3	8	5.5
20	5.5	36	8	4	1.5	M4 × 0.7	13	3	9	5.5
25	6	42	10	4	2	M5 × 0.8	17	3	9.2	5.5
32	7	50	12	4	2.4	M6 × 1	22	3	9	9
40	7	58.5	12	4	3	M8 × 1.25	28	3	9.5	7.5
50	9	71.5	15	5	4	M10 × 1.5	38	3	10.5	10.5
63	9	84.5	15	5	4	M10 × 1.5	40	3	12	11

Bore size\Item	O	P1
12	M5 × 0.8	2-Sides: φ 6.5 Thread M5 × 0.8 Thru.hole: φ 4.2
16	M5 × 0.8	2-Sides: φ 6.5 Thread M5 × 0.8 Thru.hole: φ 4.2
20	M5 × 0.8	2-Sides: φ 6.5 Thread M5 × 0.8 Thru.hole: φ 4.2
25	M5 × 0.8	2-Sides: φ 8.2 Thread M6 × 1.0 Thru.hole: φ 4.6
32	1/8"	2-Sides: φ 8.2 Thread M6 × 1.0 Thru.hole: φ 4.6
40	1/8"	2-Sides: φ 10 Thread M8 × 1.25 Thru.hole: φ 6.5
50	1/4"	2-Sides: φ 11 Thread M8 × 1.25 Thru.hole: φ 6.5
63	1/4"	2-Sides: φ 11 Thread M8 × 1.25 Thru.hole: φ 6.5

Bore size\Item	P3	P4	R	S	T1	T2	V	W	X	Y
12	12	4.5	-	25	16.2	23	6	5	-	-
16	12	4.5	-	29	19.8	28	6	5	-	-
20	14	4.5	2	34	24	-	8	6	11.3	10
25	15	5.5	2	40	28	-	10	8	12	10
32	16	5.5	6	44	34	-	12	10	18.3	15
40	20	7.5	6.5	52	40	-	16	14	21.3	16
50	25	8.5	9.5	62	48	-	20	17	30	20
63	25	8.5	9.5	75	60	-	20	17	28.7	20

SDA Series

Dimensions of male thread

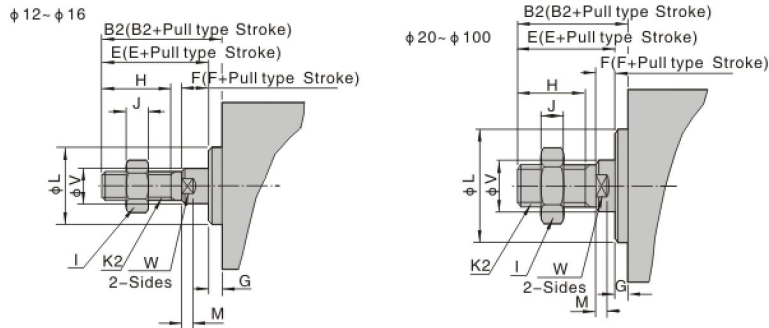

Item Bore size	B2	E	F	G		H	I	J	K2	L	M	V	W
				Others	SDAD\SDAJ								
12	17	16	4		1	10	8	4	M5×0.8	10.2	3	6	5
16	17.5	16	4		1.5	10	8	4	M5×0.8	11	3	6	5
20	20.5	19	4		1.5	13	10	5	M6×1.0	13	3	8	6
25	23	21	4		2	15	12	6	M8×1.25	17	3	10	8
32	25	22	4	2.4	3	15	17	6	M10×1.25	22	3	12	10
40	35	32	4		3	25	19	8	M14×1.5	28	3	16	14
50	37	33	5		4	25	27	11	M18×1.5	38	3	20	17
63	37	33	5		4	25	27	11	M18×1.5	40	3	20	17
80	44	39	6		5	30	32	13	M22×1.5	45	4	25	22
100	50	45	7		5	35	36	13	M26×1.5	55	4	32	27

SDAJ

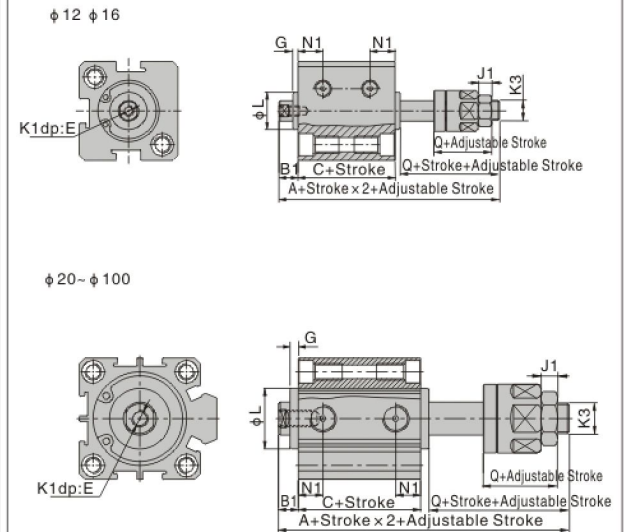

Model Bore size/Item	Without magnet		With magnet		B1	E		Q	J1
	A	C	A	C		S≤10	S>10		
12	40	17	50	27	5	6	17	4	
16	42.5	18.5	52.5	28.5	5.5	6	17	4	
20	47.5	19.5	57.5	29.5	5.5	8(S=5 is 6.5)	21	5	
25	54	21	64	31	6	10(S=5 is 7)	25	6	
32	61.5	24.5	71.5	34.5	7	8	12	6	
40	64	26	74	36	7	8	12	7	
50	70	28	80	38	9	8	15	8	
63	74	32	84	42	9	10	15	8	
80	92.5	41	102.5	51	11	13	20	10	
100	110.5	51	120.5	61	12	18	20	13.5	

Bore size/Item Stroke	G	K1	K3	L	N1	
					S=5	S>5
12	1	M3×0.5	M5X0.8	10.2	5.5	6.3
16	1.5	M3×0.5	M5X0.8	11	6.5	7.3
20	1.5	M4×0.7	M6X1.0	15	7.5	
25	2	M5×0.8	M8X1.25	17	8	
32	3	M6×1	M10X1.25	22	8	9
40	3	M8×1.25	M12X1.25	28	8	10
50	4	M10×1.5	M16X1.5	38	8	10.5
63	4	M10×1.5	M16X1.5	40	9.5	11.8
80	5	M14×1.5	M20X1.5	45	11.5	14.5
100	5	M18×1.5	M27X2.0	55	16	20.5

Remark: 1、 The unmarked dimension is the same as SDA standard type;
2、 Please refer to PV-19 for the dimension of male thread.

SDAD

φ12 φ16

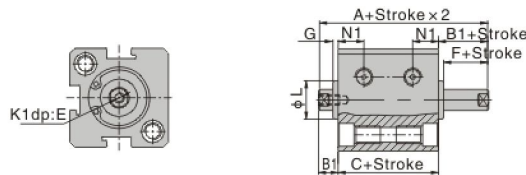

φ20-φ100

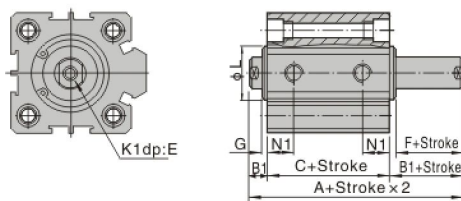

Model Bore size/Item	Without magnet		With magnet		E		B1	F	G	K1	L	N1	
	A	C	A	C	S≤10	S>10						S=5	S>5
12	27	17	37	27	6	5	4	1	M3×0.5	10.2	5.5	6.3	
16	29.5	18.5	39.5	28.5	6	5.5	4	1.5	M3×0.5	11	6.5	7.3	
20	30.5	19.5	40.5	29.5	8 (S=5 is 6.5)	5.5	4	1.5	M4×0.7	15	7.5		
25	33	21	43	31	10 (S=5 is 7)	6	4	2	M5×0.8	17	8		
32	38.5	24.5	48.5	34.5	8	12	7	4	M6×1	22	8	9	
40	40	26	50	36	8	12	7	4	M8×1.25	28	8	10	
50	46	28	56	38	8	15	9	5	M10×1.5	38	8	10.5	
63	50	32	60	42	10	15	9	5	M10×1.5	40	9.5	11.8	
80	63	41	73	51	13	20	11	6	M14×1.5	45	11.5	14.5	
100	75	51	85	61	18	20	12	7	M18×1.5	55	16	20.5	

Remark: 1、 The unmarked dimension is the same as SDA standard type;
2、 Please refer to PV-19 for the dimension of male thread.

SDA Series

SDAT

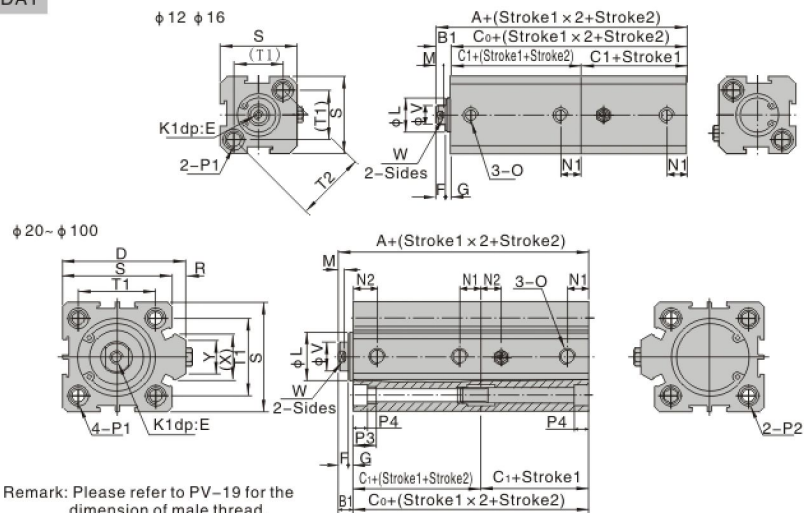

Remark: Please refer to PV-19 for the dimension of male thread.

Model	Without magnet			With magnet			B1	D	E	F	G	K1	L	M	N1		N2		O
	A	C ₀	C1	A	C ₀	C1									S=5	S>5	S=5	S>5	
12	39	34	17	59	54	27	5	-	6	4	1	M3 x 0.5	10.2	3	5	7.5		M5 x 0.8	
16	42.5	37	18.5	62.5	57	28.5	5.5	-	6	4	1.5	M3 x 0.5	11	3	5.5	8		M5 x 0.8	
20	44.5	39	19.5	64.5	59	29.5	5.5	36	8	4	1.5	M4 x 0.7	13	3	5.5	9		M5 x 0.8	
25	48	42	21	68	62	31	6	42	10	4	2	M5 x 0.8	17	3	5.5	9.2		M5 x 0.8	
32	56	49	24.5	76	69	34.5	7	50	12	4	2.4	M6 x 1	22	3	6.5	9	9	1/8"	
40	59	52	26	79	72	36	7	58.5	12	4	3	M8 x 1.25	28	3	7.5	9.5		1/8"	
50	65	56	28	85	76	38	9	71.5	15	5	4	M10 x 1.5	38	3	8	10.5	8	10.5	1/4"
63	73	64	32	93	84	42	9	84.5	15	5	4	M10 x 1.5	40	3	9.5	11	9.5	12	1/4"
80	93	82	41	113	102	51	11	104	20	6	5	M14 x 1.5	45	4	11.5	14.5	11.5	14.5	3/8"
100	114	102	51	134	122	61	12	124	20	7	5	M18 x 1.5	55	4	16	20.5	16	20.5	3/8"

Item	Bore size	X	Y	W	P1		P2		P3	P4	R	S	T1	T2	V	
					2-Sides	Thru.hole	2-Sides	Thru.hole								
12	-	-	-	5	2-Sides: φ6.5	M5 x 0.8	Thru.hole: φ4.2	-	12	4.5	-	25	16.2	23	6	
16	-	-	-	5	2-Sides: φ6.5	M5 x 0.8	Thru.hole: φ4.2	-	12	4.5	-	29	19.8	28	6	
20	11.3	10	6	6	2-Sides: φ6.5	M5 x 0.8	Thru.hole: φ4.2	2-Sides: φ6.5	Thru.hole: φ5.2	14	4.5	2	34	24	-	8
25	12	10	8	8	2-Sides: φ8.2	M6 x 1.0	Thru.hole: φ4.6	2-Sides: φ8.2	Thru.hole: φ6.2	15	5.5	2	40	28	-	10
32	18.3	15	10	10	2-Sides: φ8.2	M6 x 1.0	Thru.hole: φ4.6	2-Sides: φ8.2	Thru.hole: φ6.2	16	5.5	6	44	34	-	12
40	21.8	16	14	14	2-Sides: φ10	M8 x 1.25	Thru.hole: φ6.5	2-Sides: φ10	Thru.hole: φ8.2	20	7.5	6.5	52	40	-	16
50	30	20	17	17	2-Sides: φ11	M8 x 1.25	Thru.hole: φ6.5	2-Sides: φ11	Thru.hole: φ8.5	25	8.5	9.5	62	48	-	20
63	28.7	20	17	22	2-Sides: φ11	M8 x 1.25	Thru.hole: φ6.5	2-Sides: φ11	Thru.hole: φ8.5	25	8.5	9.5	75	60	-	20
80	36	26	22	22	2-Sides: φ14	M12 x 1.75	Thru.hole: φ9.2	2-Sides: φ14	Thru.hole: φ12.3	25	10.5	10	94	74	-	25
100	35	26	27	27	2-Sides: φ17.5	M14 x 2	Thru.hole: φ11.3	2-Sides: φ17.5	Thru.hole: φ14.2	30	13	10	114	90	-	32

Model	Without magnet			With magnet			B1
	A	C ₀	C1	A	C ₀	C1	
12	44	34	17	64	54	27	5
16	48	37	18.5	68	57	28.5	5.5
20	50	39	19.5	70	59	29.5	5.5
25	54	42	21	74	62	31	6
32	63	49	24.5	83	69	34.5	7
40	66	52	26	86	72	36	7
50	74	56	28	94	76	38	9
63	82	64	32	102	84	42	9
80	104	82	41	124	102	51	11
100	126	102	51	146	122	61	12

Bore size/Item	D	E	F	G	K1	L	M
16	-	6	4	1.5	M3 x 0.5	11	3
20	36	8	4	1.5	M4 x 0.7	13	3
25	42	10	4	2	M5 x 0.8	17	3
32	50	12	4	2.4	M6 x 1	22	3
40	58.5	12	4	3	M8 x 1.25	28	3
50	71.5	15	5	4	M10 x 1.5	38	3
63	84.5	15	5	4	M10 x 1.5	40	3
80	104	20	6	5	M14 x 1.5	45	4
100	124	20	7	5	M18 x 1.5	55	4

Bore size/Item	N2		N1		O	X	Y
	S=5	S>5	S=5	S>5			
12	7.5		5		M5 x 0.8	-	-
16	8		5.5		M5 x 0.8	-	-
20	9		5.5		M5 x 0.8	11.3	10
25	9.2		5.5		M5 x 0.8	12	10
32	9	6.5	9		1/8"	18.3	15
40	9.5		7.5		1/8"	21.3	16
50	8	10.5	8	10.5	1/4"	30	20
63	9.5	12	9.5	11	1/4"	28.7	20
80	11.5	14.5	11.5	14.5	3/8"	36	26
100	16	20.5	16	20.5	3/8"	35	26

SDAW

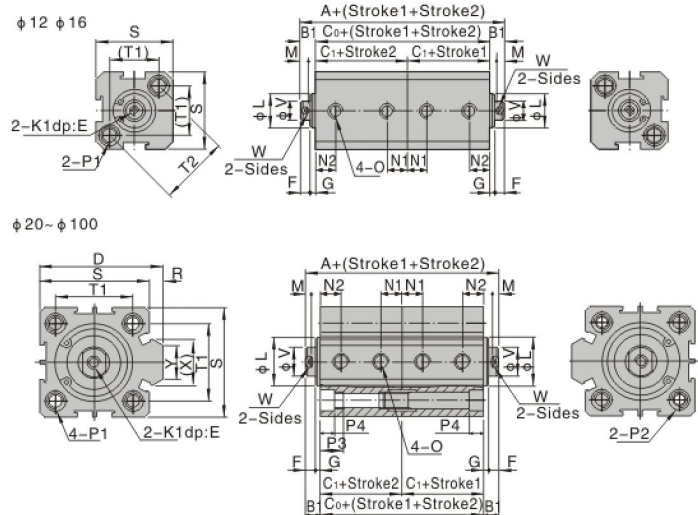

Remark: Please refer to PV-19 for the dimension of male thread.

Bore size/Item	P1		P2		
	2-Sides	Thru.hold	2-Sides	Thru.hold	
12	2-Sides: φ6.5	M5 x 0.8	Thru.hold: φ4.2	-	
16	2-Sides: φ6.5	M5 x 0.8	Thru.hold: φ4.2	-	
20	2-Sides: φ6.5	M5 x 0.8	Thru.hold: φ4.2	2-Sides: φ6.5	Thru.hold: φ5.2
25	2-Sides: φ8.2	M6 x 1.0	Thru.hold: φ4.6	2-Sides: φ8.2	Thru.hold: φ6.2
32	2-Sides: φ8.2	M6 x 1.0	Thru.hold: φ4.6	2-Sides: φ8.2	Thru.hold: φ6.2
40	2-Sides: φ10	M8 x 1.25	Thru.hold: φ6.5	2-Sides: φ10	Thru.hold: φ8.2
50	2-Sides: φ11	M8 x 1.25	Thru.hold: φ6.5	2-Sides: φ11	Thru.hold: φ8.5
63	2-Sides: φ11	M8 x 1.25	Thru.hold: φ6.5	2-Sides: φ11	Thru.hold: φ8.5
80	2-Sides: φ14	M12 x 1.75	Thru.hold: φ9.2	2-Sides: φ14	Thru.hold: φ12.3
100	2-Sides: φ17.5	M14 x 2	Thru.hold: φ11.3	2-Sides: φ17.5	Thru.hold: φ14.2

Bore size/Item	W	P3	P4	R	S	T1	T2	V
16	5	12	4.5	-	29	19.8	28	6
20	6	14	4.5	2	34	24	-	8
25	8	15	5.5	2	40	28	-	10
32	10	16	5.5	6	44	34	-	12
40	14	20	7.5	6.5	52	40	-	16
50	17	25	8.5	9.5	62	48	-	20
63	17	25	8.5	9.5	75	60	-	20
80	22	25	10.5	10	94	74	-	25
100	27	30	13	10	114	90	-	32